

salzer
MODULAR SWITCHES

Le' Royalé
COLLECTION



SWITCHES | SOCKETS | PLATES | SPECIALITY PRODUCTS | ACCESSORIES



Salzer Electronics Limited is one among the leading manufacturers in the world to design, manufacture and market Cam Operated Rotary switches. An ISO 9001:2000 certified company, Salzer has been recognized as a major R&D centre by the Ministry of Science & Technology, Government of India.

Salzer has a state of the art manufacturing facility, a world class R&D to design & manufacture the best of electrical & electronic products. Salzer range of products are patronised in over 41 countries across 6 continents.

Salzer's range includes Rotary Switches, Load Break Switches, Cable Channels, Proximity Switches, Automobile Switches, Terminal Connectors, Toroidal Transformers, Limit & Foot Switches. Salzer products carry international certifications viz: UL, CSA , VDE & CE mark beside the ISI for the Indian market.

Salzer is proud to introduce Le'Royale Collection of Modular Switches, Sockets, Accessories & Specialities - a whole new range of products for the Indian market. If it is Salzer it has to be the best...





- Aesthetic and design to suit your taste and needs
- User friendly modular construction, simple to assemble & install
- Higher 'silver' contact area for enhanced operational life
- Smooth operation of switches - akin to feather touch feel
- Rugged construction and tested components to ensure reliability & safety
- State of the art latest technology in speciality products
- A Comprehensive range.
- Salzer's guarantee for total satisfaction in performance and service

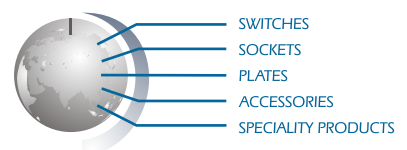

Le' Royalē

COLLECTION

STYLING



Classics in White...

Modular Switches

Le'Royale Collection of switches in white are Classics in gloss finish made of high resistance plastics and are of extremely smooth finish. Le'Royale Switches have enhanced durability & electrical life, pass through stringent tests and conforms to ISI & CSA standards. Available in popular 10 & 20 ampere rating.



Combination socket - 6 & 16 amps



Dimmer



5 Step Regulator

Le'Royale Switches and Plate assemblies make a perfect set offering unlimited choice of combinations with flexibility to 'mix and match'. Choose any wall finish and decor that you like, there is always a Classic in White that would fit the bill and adorn your home or office.

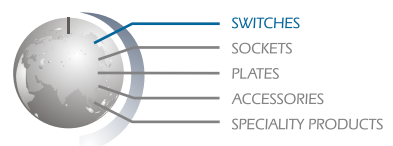

Le' Royalé
COLLECTION

BLACK



Black is Beautiful...

Modular Switches

Black is beautiful and so are the Le'Royale Blacks. Le'Royale Collection - a premium range of switches are made for the contemporary settings and the decor. The Matte Black has superior finish of a velvet and engineered for enhanced electrical life. Each Le'Royale Black passes through stringent tests and conform to ISI & CSA standards. Available in popular 10 & 20 ampere rating.



Switches available in 10 & 20 ampere rating.

Le'Royale Switches and Plate assemblies are made for 'mix and match' combinations. There is always a Le'Royale Black switch and a matching plate assembly that would adorn the interiors of your homes.

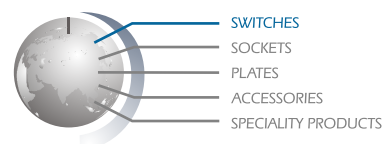

Le' Royalé
COLLECTION

SPECIALTIES

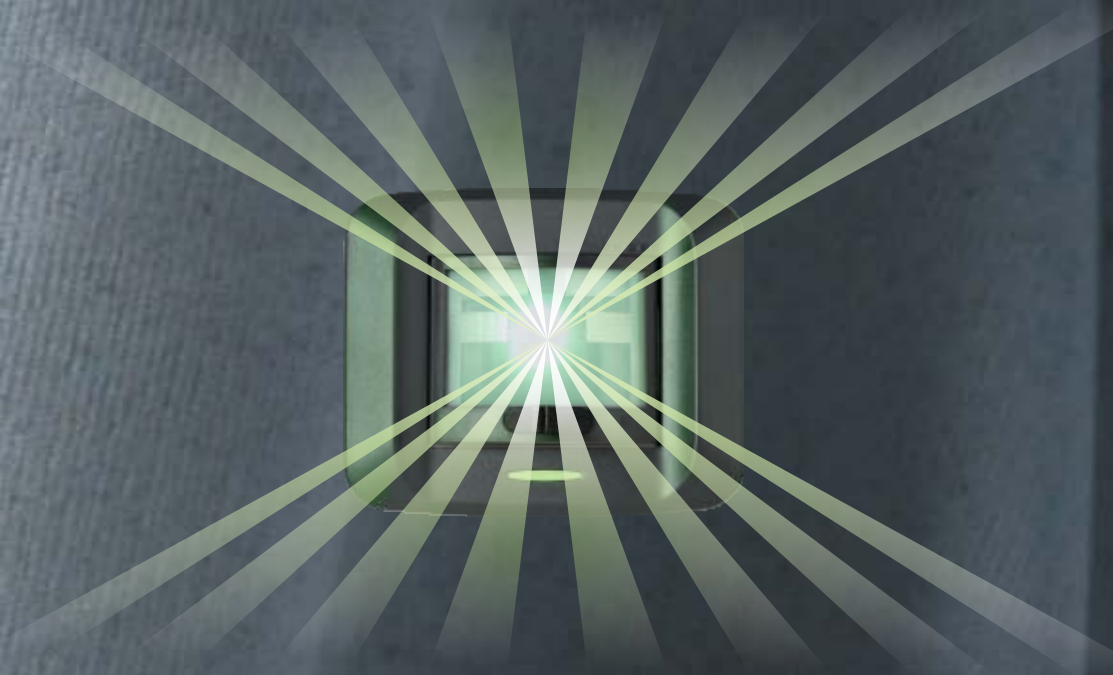

ENERGY SAVING DEVICES



Specialities



Shock Protector

Single phase starter

Le'Royale Collection of speciality product includes single phase starters, shock protectors, programmable timers, etc... Le'Royale Shock protector is a sophisticated , residual Current Operated protective device. Le' Royale safety for you... All the way.

24*7 days Programmable timer is an energy saving device when connected to your AC, Motor Pumps ,Water Heaters etc.,

Le'Royale Specialities like the versatile Movement sensor not only saves you on electricity bill but also can be connected for security of home or office. Connect it to your fans & lighting systems and see it operate as a watch Dog of your electricity Consumption.



Remote switch



Key Tag switch

Shaver Socket

One & Two channel Remote switch with Dimmer and Preset time delay is an exclusive product for your home and offices. Le'Royale Hospitality collection comprises of Electronic Time delay Key Tag Switch & Shaver Socket with 110/240V output, is ideal for Hotel and Hospitals.

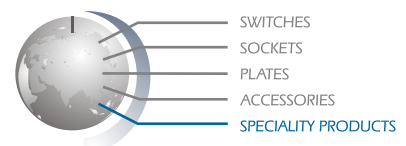



Le'Royalē GLOW

- BLACK
- WHITE
- TEAK GLOSS
- TEAK MATTE
- CHROME
- MARBLE
- PISTA
- SILVER
- BLUE
- GOLD
- DARK BROWN

PLATE ASSEMBLY

Mounting Diagram



Installation Procedure

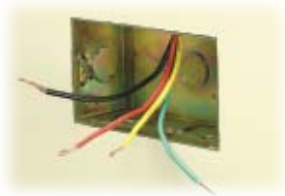

Retain protective sheet if painting is incomplete



When painting is completed remove the protective sheet from the front panel

Ensure safety rules are followed. Check the mains are switched off. Double check current flow by using good quality tester. Tighten contact screws thoroughly to avoid loose termination. Do not over tighten the screws , it could damage the modular units.



Concealed metal box

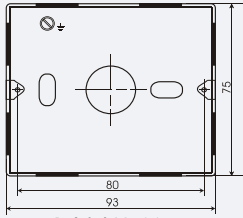

1, 2 & 3 Module

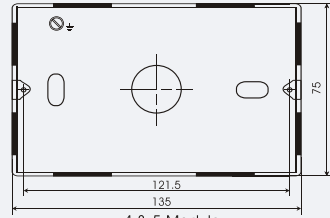

4 & 5 Module

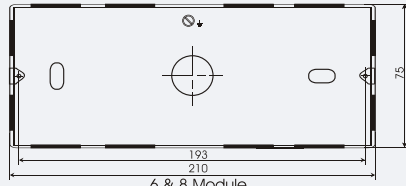

6 & 8 Module

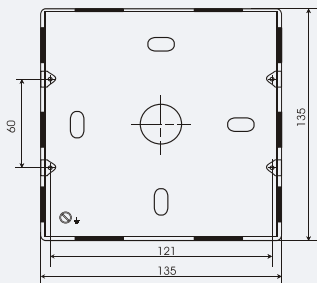

8 & 10 Module

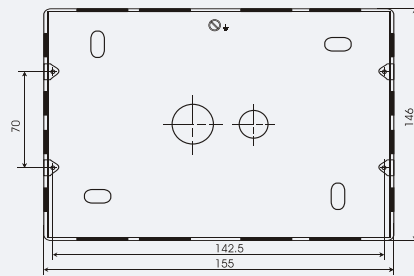

12 Module

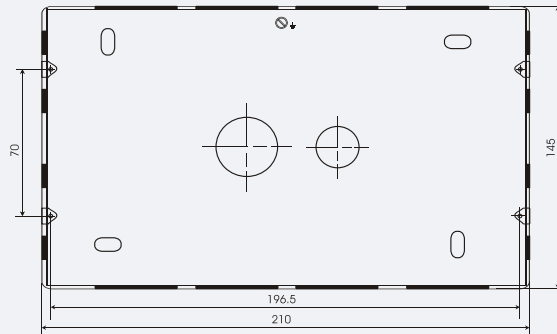

16 Module

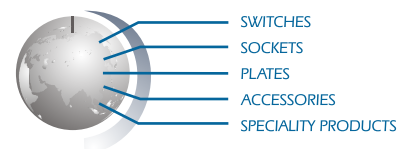

Mounting Frame

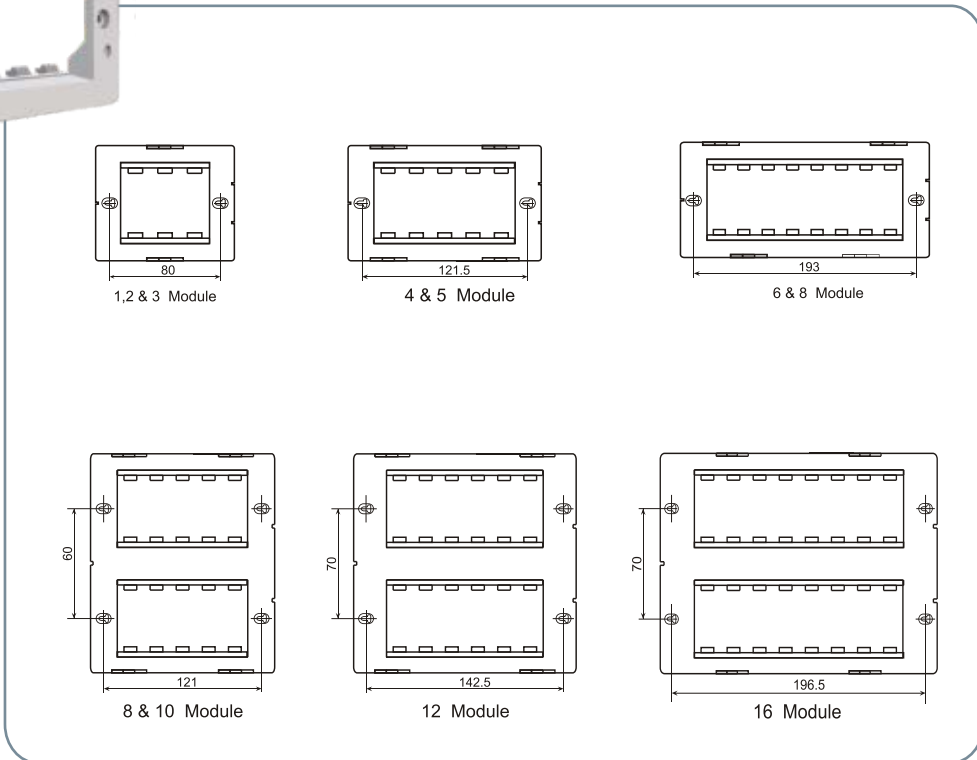

Front Panel

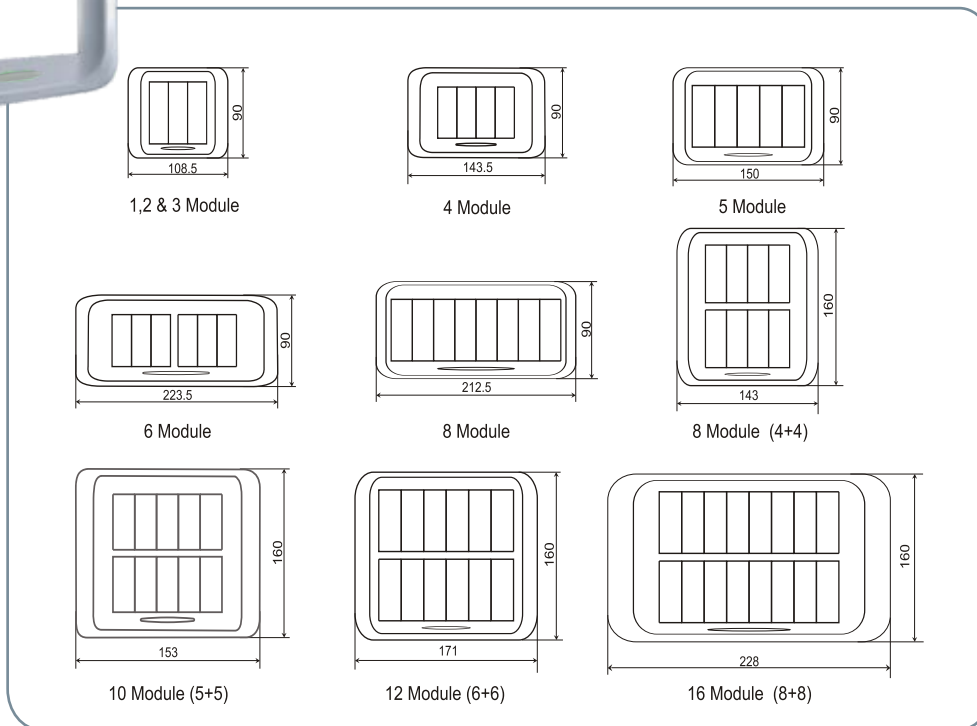

- SWITCHES
- SOCKETS
- PLATES
- ACCESSORIES
- SPECIALITY PRODUCTS

DESCRIPTION	CAT # WHITE	CAT # BLACK	
10 AMPS SWITCH <small>WITHOUT INDICATION</small>	S101W	S101B	SWITCHES
10 AMPS SWITCH <small>WITH INDICATION</small>	S101WL	S101BL	
10 AMPS TWO WAY SWITCH <small>WITHOUT INDICATION</small>	S102W	S102B	
10 AMPS BELL PUSH SWITCH <small>WITHOUT INDICATION</small>	S10BW	S10BB	
10 AMPS BELL PUSH SWITCH <small>WITH INDICATION</small>	S10BWL	S10BBL	
20 AMPS SWITCH <small>WITHOUT INDICATION</small>	S201W	S201B	
20 AMPS SWITCH <small>WITH INDICATION</small>	S201WL	S201BL	
20 AMPS TWO WAY SWITCH <small>WITHOUT INDICATION</small>	S202W	S202B	
32 AMPS DOUBLE POLE SWITCH <small>WITH INDICATION</small>	S32DW	S32DB	
<hr/>			
6 AMPS TWO PIN SOCKET	S0062W	S0062B	SOCKETS
6 AMPS FIVE PIN SOCKET	S0065W	S0065B	
6/16 AMPS COMBINATION SOCKET	S016CW	S016CB	
TELEPHONE PLUG-TWO PIN	TP2W	TP2B	
TELEPHONE SOCKET-TWO PIN	TS2W	TS2B	
RJ 11 - TELEPHONE JACK - 2 WIRE	TJ2W	TJ2B	
RJ 11 - TELEPHONE JACK - 4 WIRE	TJ4W	TJ4B	
RJ 45 - COMPUTER JACK	COJW	COJB	
TELEVISION SOCKET-PIN TYPE	TVSW	TVSB	
<hr/>			
FAN REGULATOR	FRGW	FRGB	ACCESSORIES
DIMMER 400 watts	D400 W	D400B	
DIMMER 600 watts	D600 W	D600B	
DIMMER 1000 watts	D1000 W	D1000B	
FUSE UNIT 6 Amps	FU06W	FU06B	
FUSE UNIT 16 Amps	FU16W	FU16B	
BLANK PLATE	SBPW	SBPB	
<hr/>			
SINGLE PHASE MOTOR STARTER (4-6.5)Amps	-	ST06B	SPECIALTIES
SINGLE PHASE MOTOR STARTER (6-10)Amps	-	ST10B	
SINGLE PHASE MOTOR STARTER (7.5-12)Amps	-	ST12B	
SINGLE PHASE MOTOR STARTER (9-15)Amps	-	ST15B	
SINGLE PHASE MOTOR STARTER (13-21)Amps	-	ST18B	
SHOCK PROTECTOR	-	SP15B	
MOVEMENT DETECTOR	-	HMDLB	
TIMER 24*7 HOURS	-	TMRB	
KEY TAG SWITCH <small>(INCLUSIVE OF METAL BOX)</small>	KTSW	-	
SHAVER SOCKET <small>(INCLUSIVE OF METAL BOX)</small>	SSOW	-	
REMOTE SWITCH - 1 CHANNEL <small>(INCLUSIVE OF METAL BOX)</small>	RS1W	-	
REMOTE SWITCH - 2 CHANNEL <small>(INCLUSIVE OF METAL BOX)</small>	RS2W	-	

REPRESENTATION

Wiring Diagram

One-Way Switch

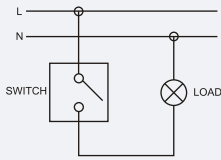

Two-Way Switch

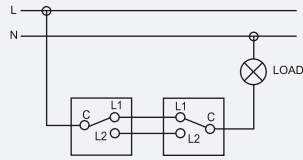

Double pole Switch

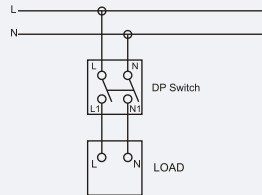

Bell Switch

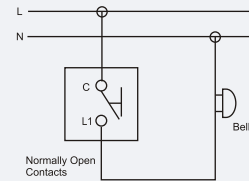

Computer Outlet - RJ45

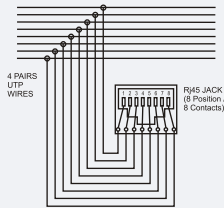

Wiring Colour Code		
Pin Number	EIA-T568A Wire Colour	EIA-T568B Wire Colour
1	White/Green	White/Orange
2	Green	Orange
3	White/Orange	White/Green
4	Blue	Blue
5	White/Blue	White/Blue
6	Orange	Green
7	White/Brown	White/Brown
8	Brown	Brown

Telephone Outlet - RJ11

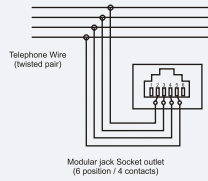

Wiring Colour Code		
Pin Number	Base Colour	Indication
1	-	-
2	Black	Earth
3	Red	L2
4	Green	L1
5	Yellow	Spare
6	-	-

1 Gang TV Outlet

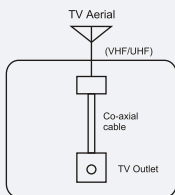

Dimmer with Switch

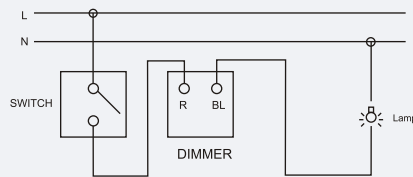

R-Red wire, BL-Blue wire, B-Black wire

Fan Regulator with switch

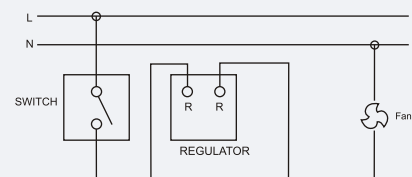

Shock Protector with Indicator Switch

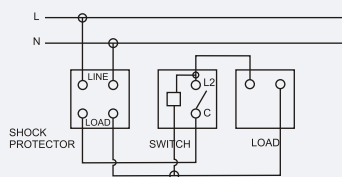

Movement Detector with bypass switch

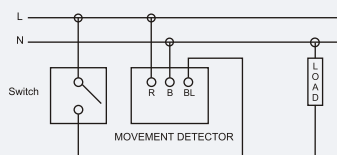

R-Red wire, BL-Blue wire, B-Black wire

Programmable Timer - 24*7

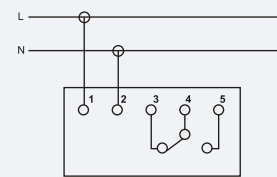

Salzer is an ISO certified company manufacturing world class Cam operated switches & accessories. Salzer markets spread across the globe in over 41 countries. Salzer products are approved, recognized and accepted for its quality & reliability.

Product improvement is a continuous process. Hence data given in this catalogue is subject to change without prior intimation.

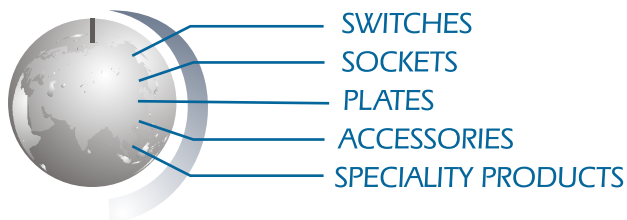

Salzer Electronics Limited

Samichettipalayam, Coimbatore - 641 047. India Ph : 91-422-2692531
Fax : 91-422 - 2692170 email : salzer@vsnl.com www.salzergroup.net